

Mira 44 2,5x2,5

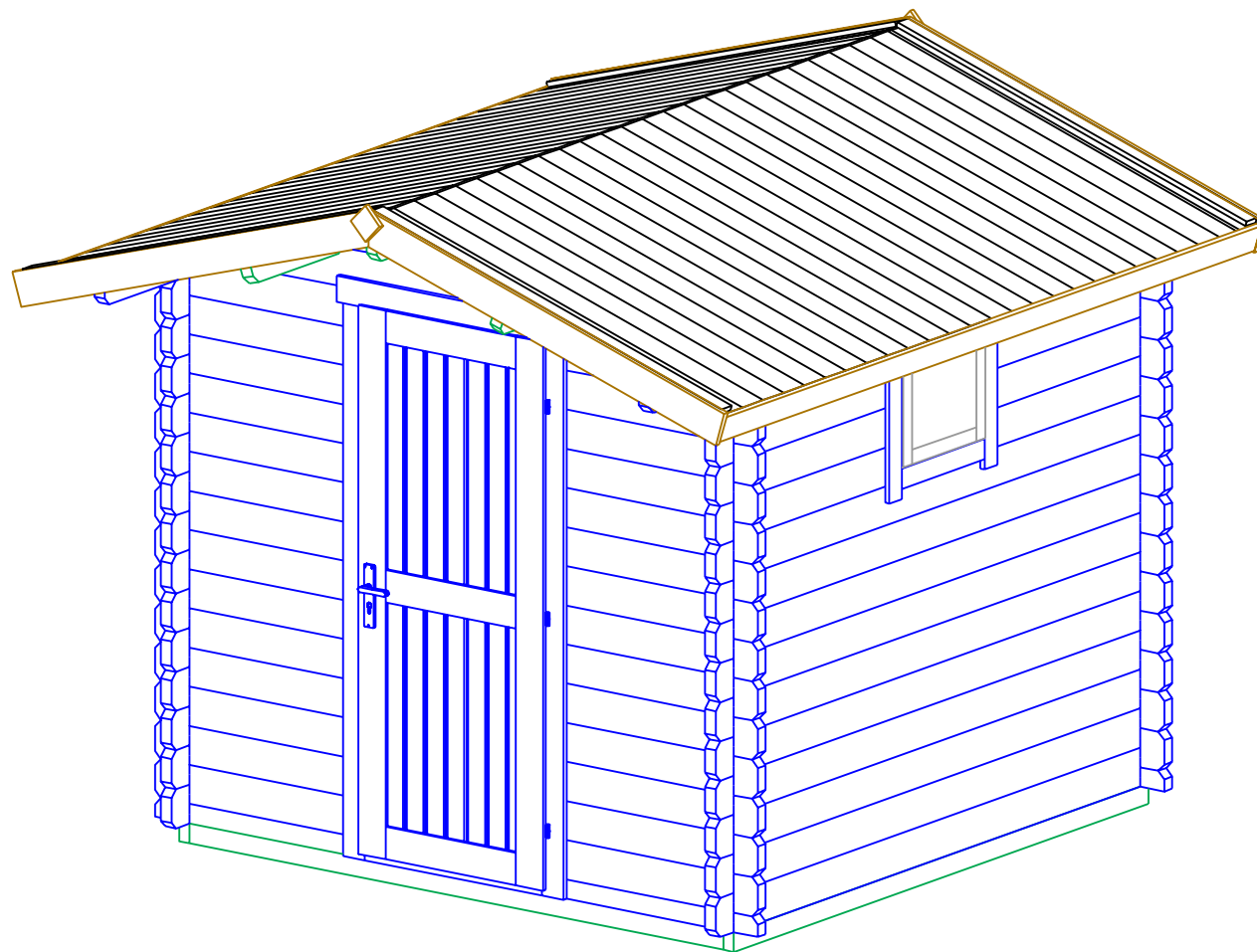

Mira 44 2,5x2,5

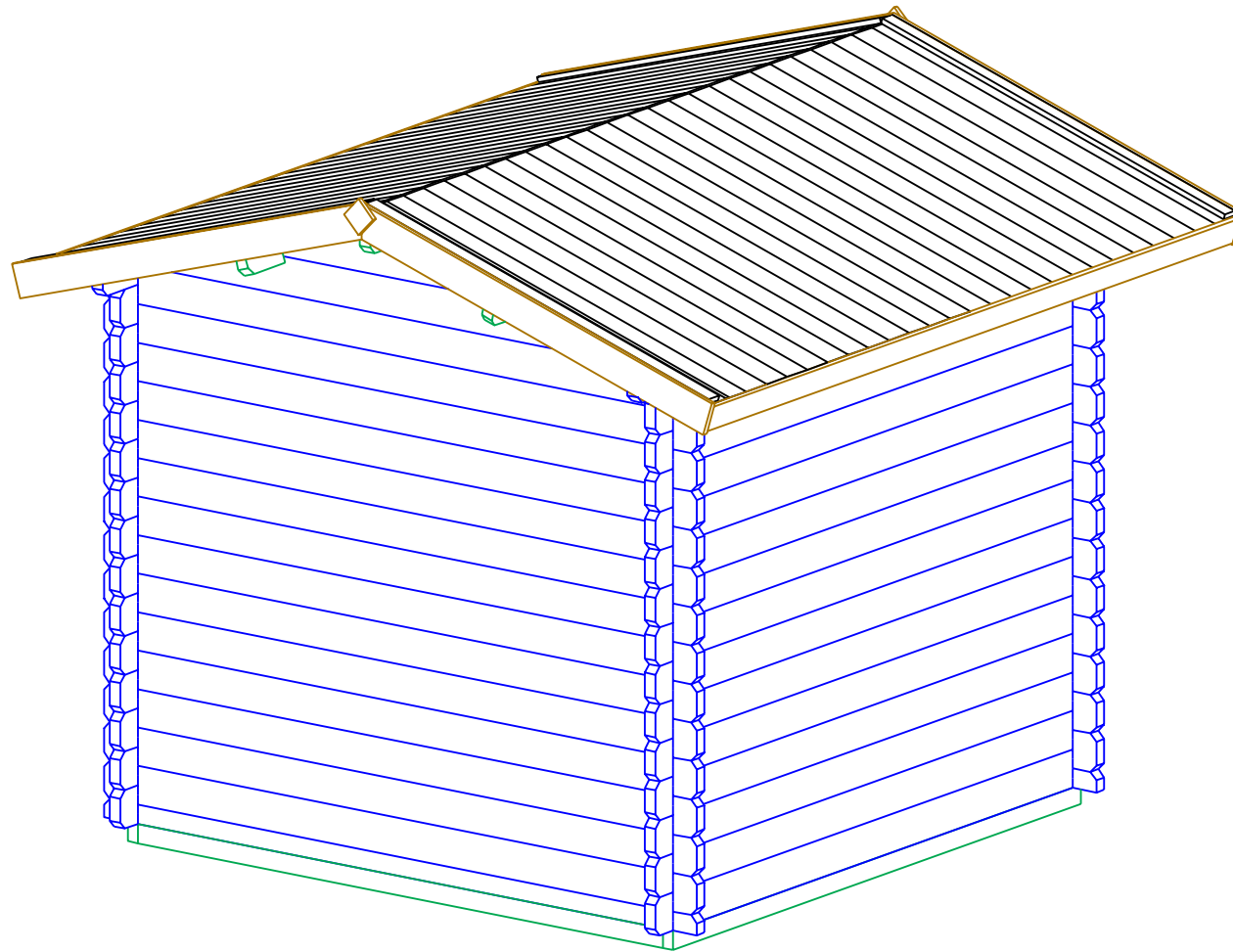

Mira 44 2,5x2,5

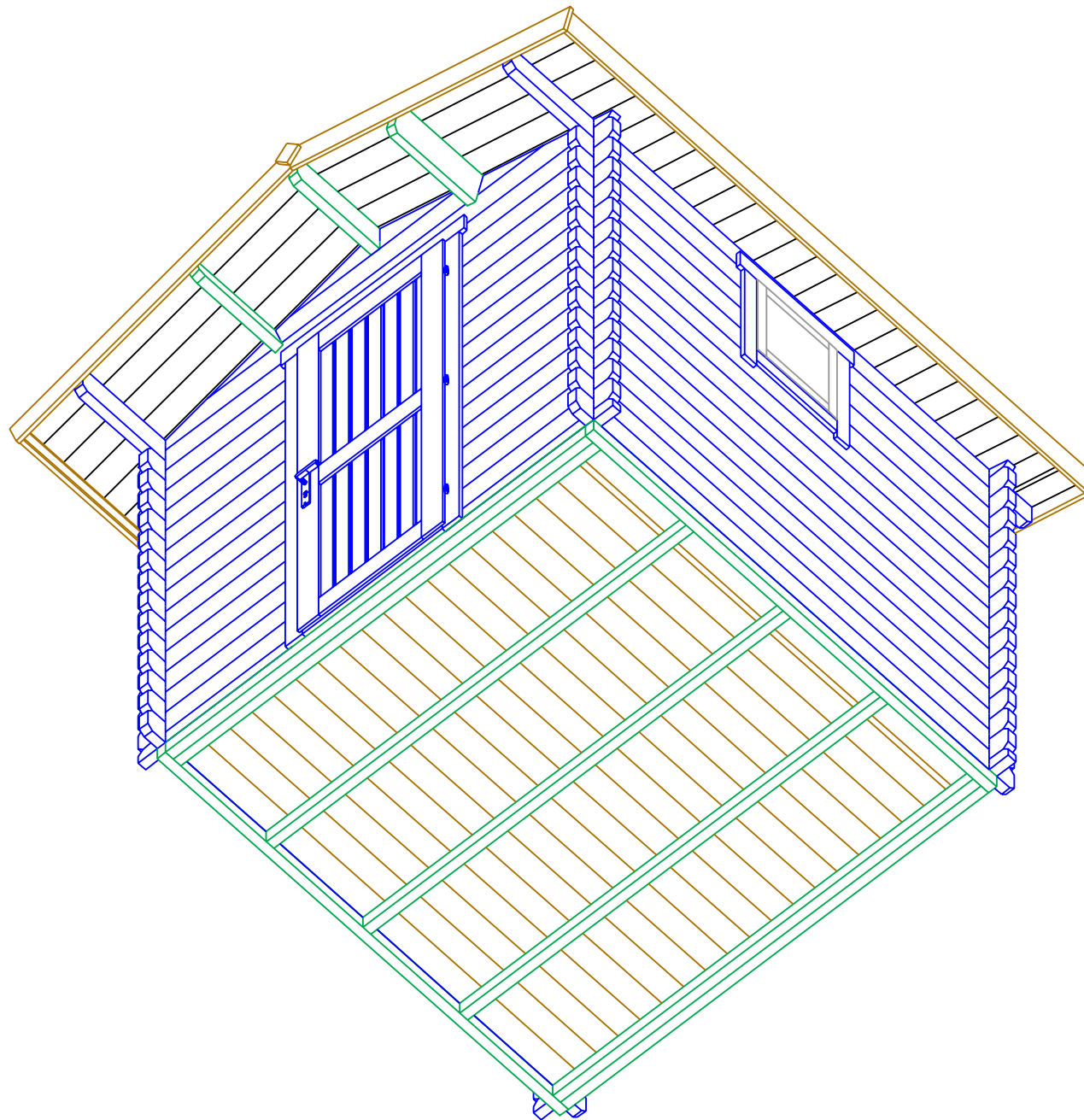

Mira 44 2,5x2,5  
Plan

Стена B  
Wand B  
Wall B  
Mur B  
↓

Стена C  
Wand C  
Wall C  
Mur C  
→

Стена D  
Wand D  
Wall D  
Mur D  
←

↑  
Стена A  
Wand A  
Wall A  
Mur A

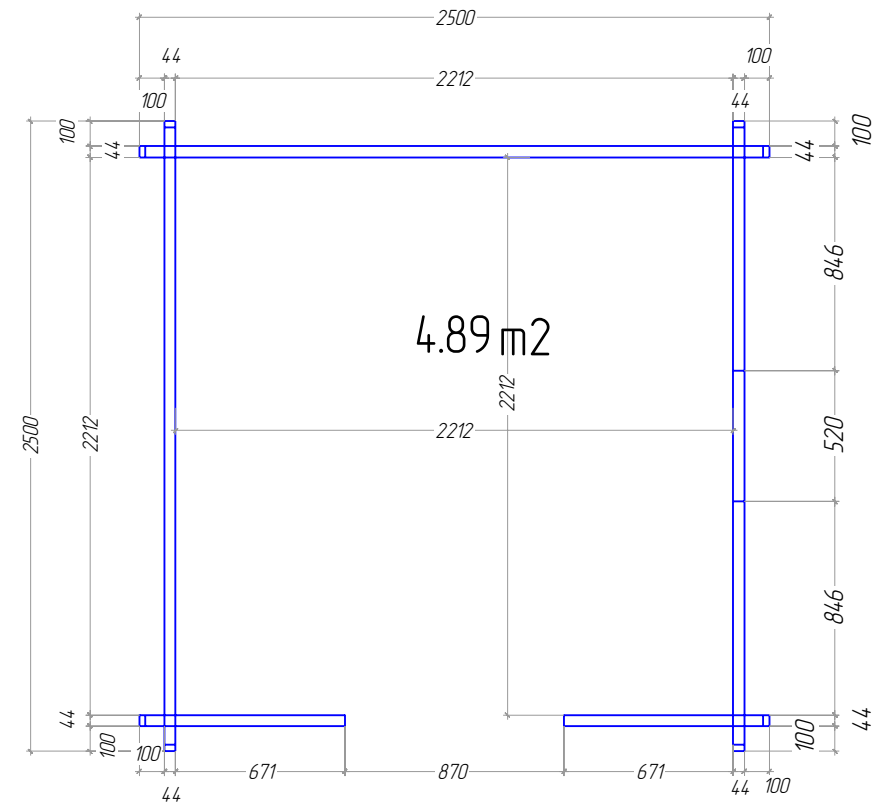

Mira 44 2,5x2,5

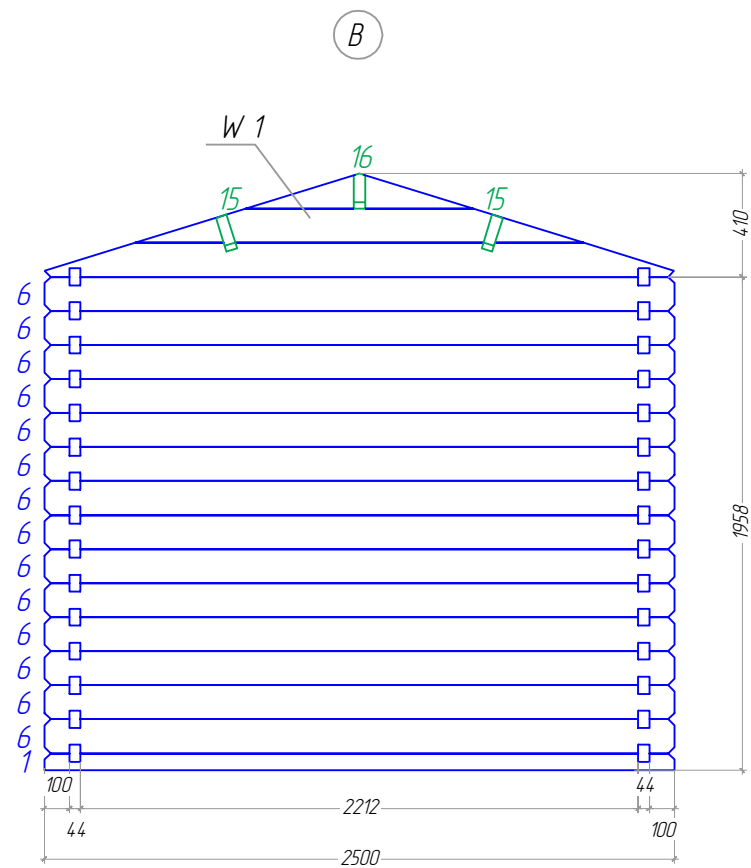
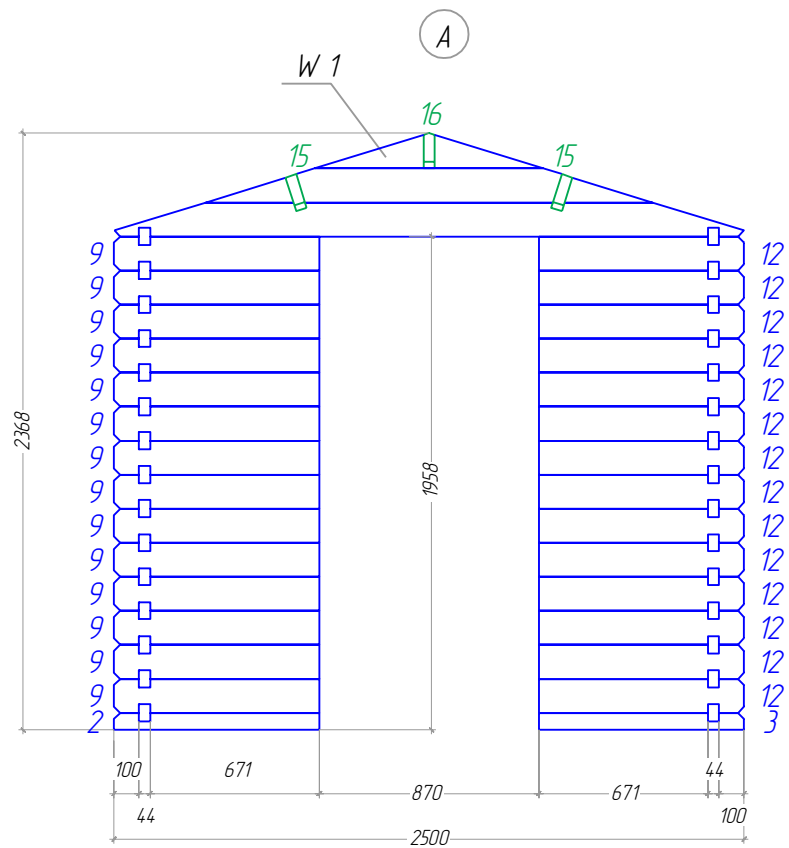

# Mira 44 2,5x2,5

Ⓒ

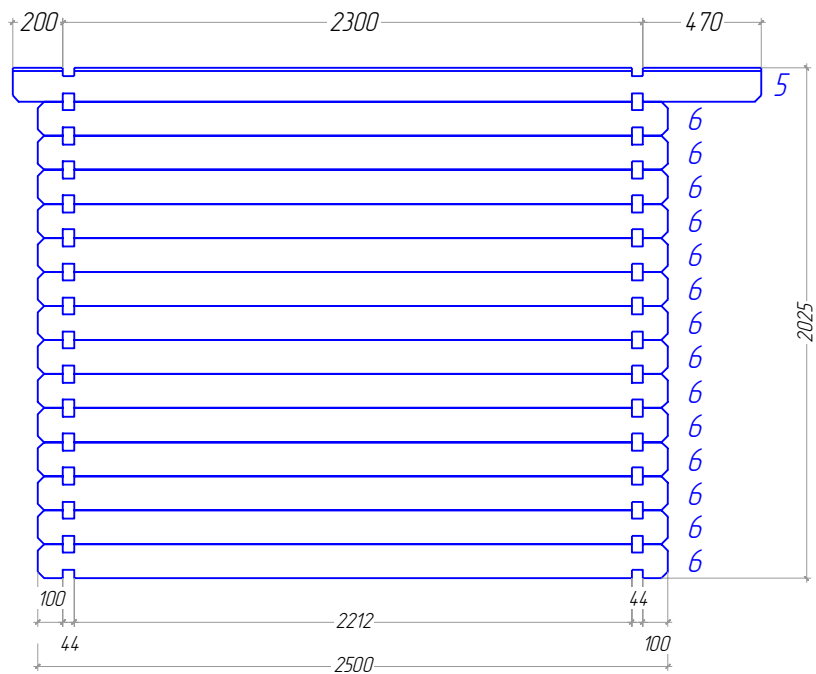

Ⓓ

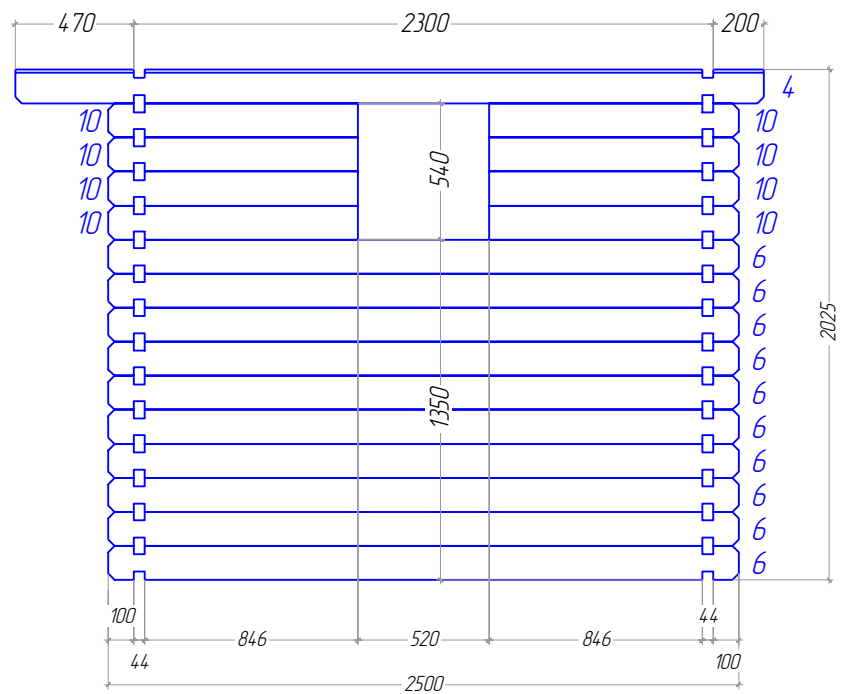

Mira 44 2,5x2,5

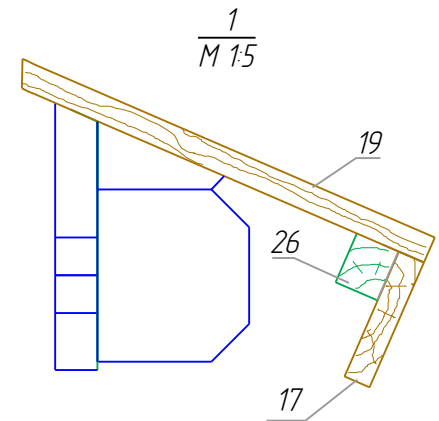
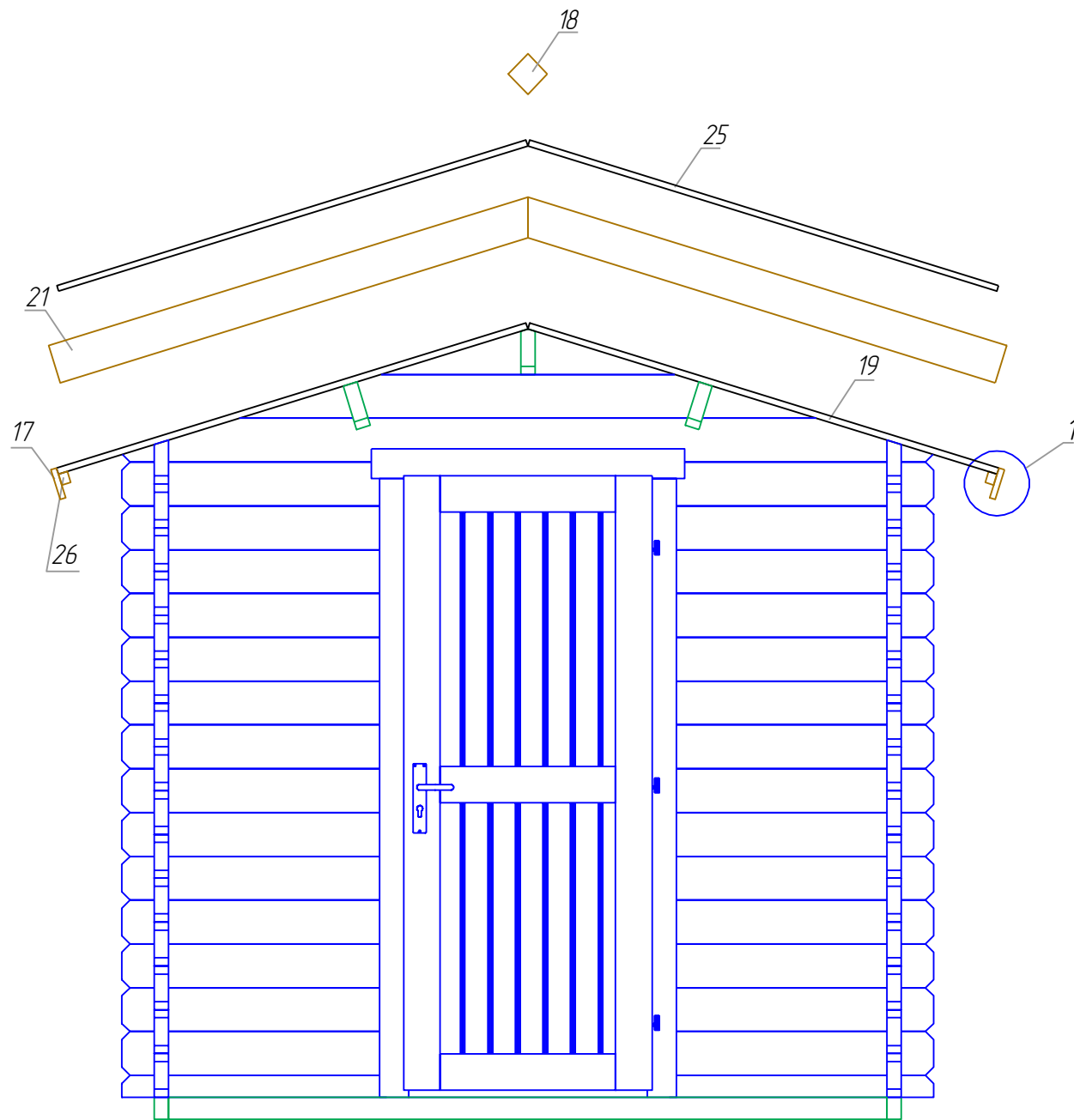

Mira 44 2,5x2,5

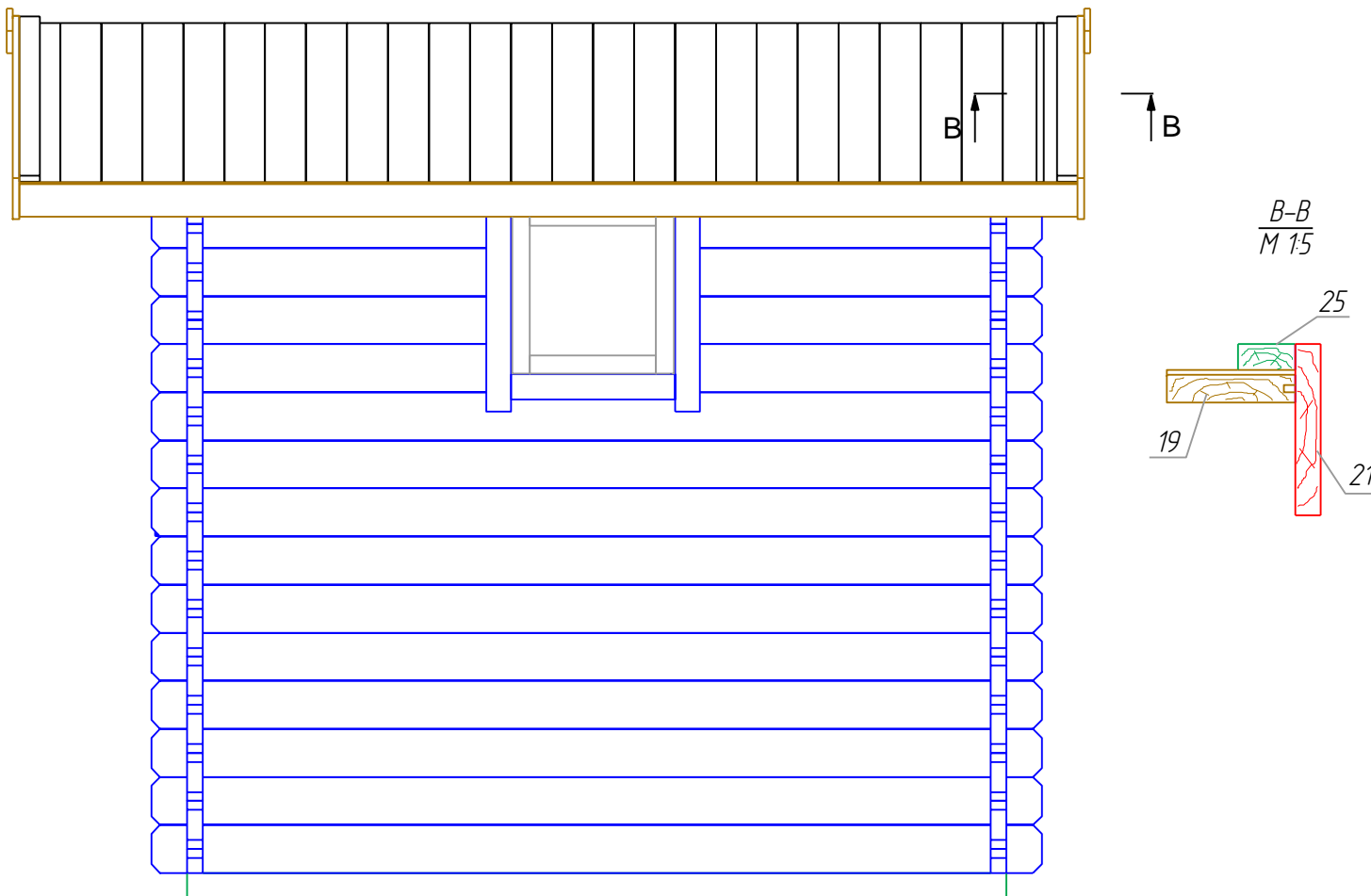



# Mira 44 2,5x2,5



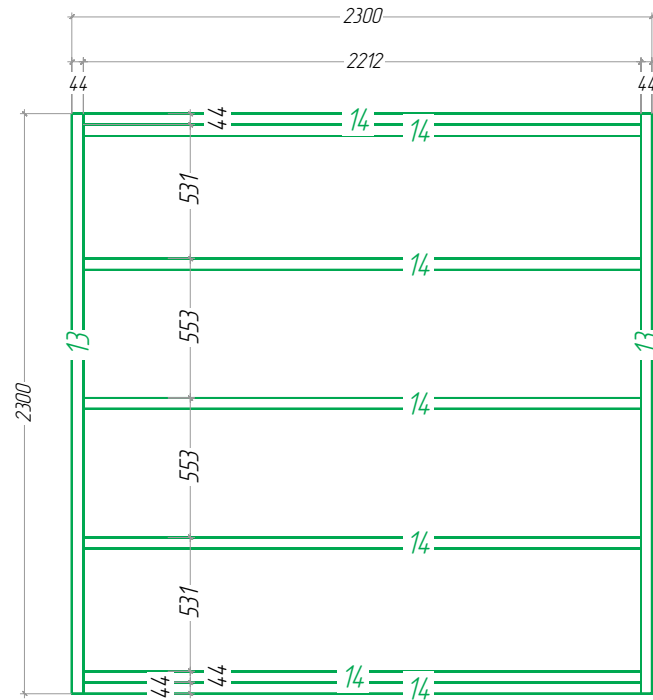

Boarding joist plan  
Trumplan  
Lambourde plan



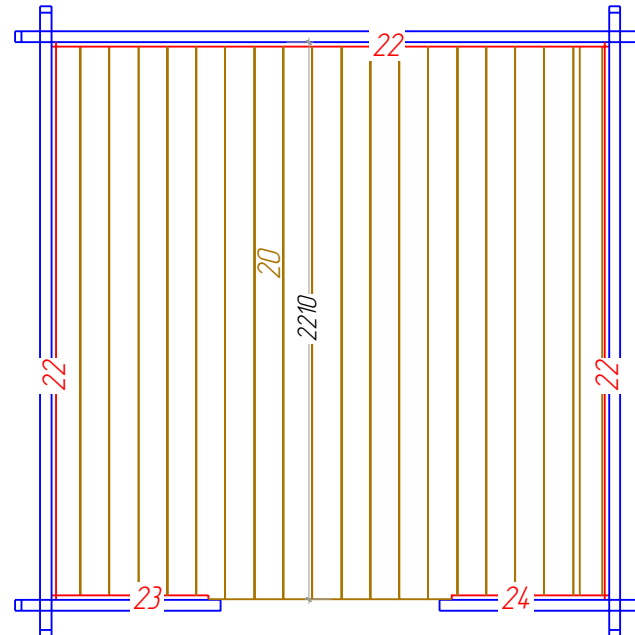

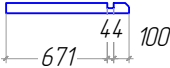
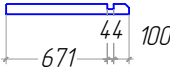
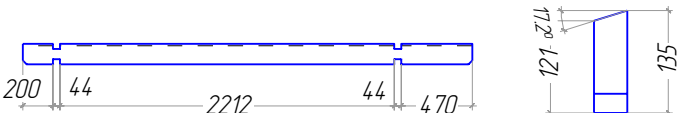
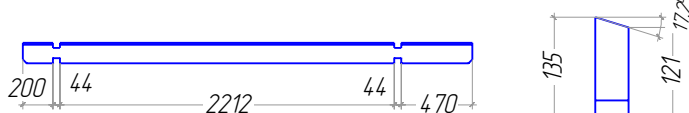

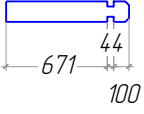
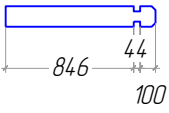
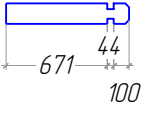

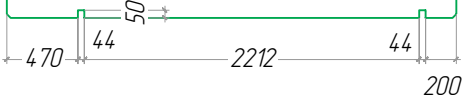
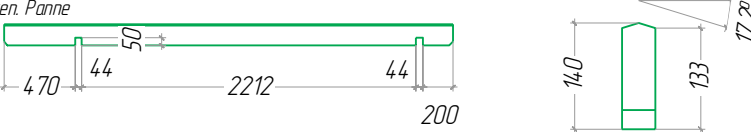

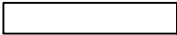

# Mira 44 2,5x2,5

Plan of the floor board  
Plan der Furbodenbretter  
Le plan des plaches du plancher



№	Mira 44 2,5x2,5	Nr.	Profile (mm)	Lenght (mm)
1	стеновой 	1	44x68	2500mm
2	стеновой 	1	44x68	815mm
3	стеновой 	1	44x68	815mm
4	стеновой 	1	44x135	2970mm
5	стеновой 	1	44x135	2970mm
6	стеновой 	38	44x135	2500mm
9	стеновой 	14	44x135	815mm
10	стеновой 	8	44x135	990mm
12	стеновой 	14	44x135	815mm
13	Foundation Fundament Solive 	2	44x68	2300mm
14	Foundation Fundament Solive 	7	44x68	2212mm
15	Roof beam. Dachbalken. Panne 	2	44x140	2970mm
16	Roof beam. Dachbalken. Panne 	1	44x140	2970mm

№	Mira 44 2,5x2,5	Nr.	Profile (mm)	Lenght (mm)
17	Roof side boards Traufenbrett Planche de rive 	2	18x95	2970mm
18	Diamond Raute Diamant 	2	18x120	115mm
19	Roof boards Dachbretter Volige 	52	20x115	1513mm
20	Floor boards Fu ssboden Lame de plancher 	20	20x115	2208mm
21	Fascia board Giebelblende Planch de rive facade 	4	18x120	1545mm
22	Floor edge trim Fu bleisten Plinthe plancher 	3	18x20	2212mm
23	Floor edge trim Fu bleisten Plinthe plancher 	1	18x20	623mm
24	Floor edge trim Fu bleisten Plinthe plancher 	1	18x20	623mm
25	Roofing felt fillet Giebelabschlussbrett Latte de finition couverture 	4	18x58	1513mm
26	Roof edge reinforcement Traufenteistu Tasseau 	2	28x34	2970mm
	Door Tur 1958x870 мм (злухая) La porte Window 540x520 мм	1 1		

Mira 44 2,5x2,5  
2 pcs

W1

